

# LUXNERI® SERIES **N**6



# 620-640W Mono FULL BLACK

## 120 Half-Cell Layout

### G12/210mm N-TYPE Cell

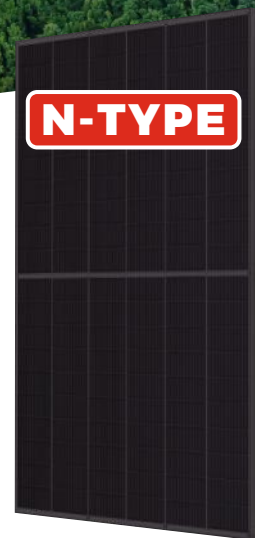

LECO N-TYPE Cell Technology



Full Black Appearance for Aesthetic Effect



SMBB Half Cut Cell Technology



Excellent Anti-PID Low LID Performance



Less Hot Spot Shading Effects



Higher Power Output Lower BOS & LCOE

### Linear Performance Warranty

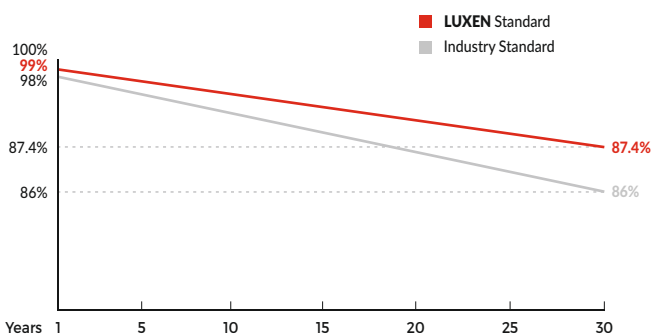

\* LUXEN N-TYPE: Standard warranty 15 years, can be extended up to 20 years.

### Insured By



### Comprehensive Certificates

- ISO9001:2015 QMS
- ISO14001:2015 EMS
- ISO45001:2018 OHSMS
- IEC61215/IEC61730 Standard Quality
- IEC61701/IEC62716 Salt/Mist/Ammonia Tests



MECHANICAL CHARACTERISTICS

Solar Cells	N-type Mono
No. of Cells	120 (6x20)
Dimensions	2172 x 1303 x 35mm
Weight	31.0kg
Front Glass	3.2mm coated tempered glass
Frame	Anodized aluminium alloy (reinforced high-load optional)
Junction Box	Ip68 rated (3 by pass diodes)
	4.0mm <sup>2</sup>
Output Cables	250mm (+) / 350mm (-)
	Length can be customized
Connectors	Mc4 compatible
Mechanical load test	Front 5400Pa / Rear 2400Pa

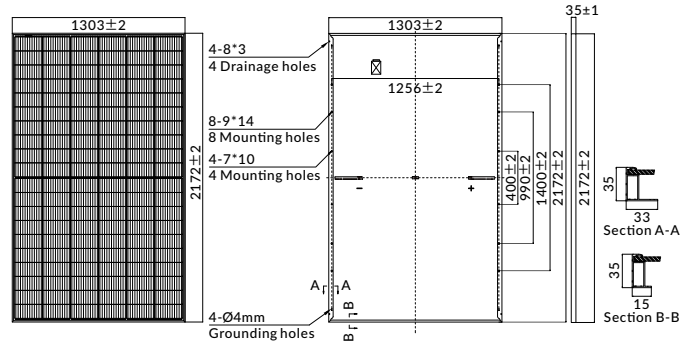

ELECTRICAL PARAMETERS

POWER CLASS	LNEK-620N		LNEK-625N		LNEK-630N		LNEK-635N		LNEK-640N	
	STC	NMOT	STC	NMOT	STC	NMOT	STC	NMOT	STC	NMOT
Maximum power (Pmax)	620W	472W	625W	476W	630W	480W	635W	484W	640W	488W
Open Circuit Voltage (Voc)	43.77V	40.64V	43.93V	40.78V	44.09V	40.91V	44.24V	41.05V	44.40V	41.18V
Short Circuit Current (Isc)	18.15A	14.90A	18.21A	14.96A	18.27A	15.02A	18.33A	15.08A	18.39A	15.14A
Voltage at Maximum power (Vmpp)	36.26V	33.45V	36.42V	33.59V	36.59V	33.73V	36.75V	33.87V	36.91V	34.01V
Current Maximum Power (Impp)	17.10A	14.11A	17.16A	14.17A	17.22A	14.23A	17.28A	14.29A	17.34A	14.35A
MODULE EFFICIENCY (%)	21.91%		22.08%		22.26%		22.44%		22.61%	

STC: Irradiance 1000W/m<sup>2</sup>, cell temperature 25°C, AM1.5G    NMOT: Irradiance 800W/m<sup>2</sup>, ambient temperature 20°C, wind speed 1m/s, AM1.5G

PACKING CONFIGURATION

Container	40'HQ
Pieces per pallet	32
Pallets per container	18
Pieces per container	576

I-V CURVE

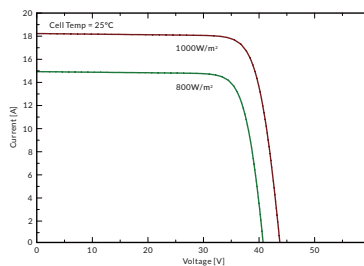

LNEK-625N/I-V

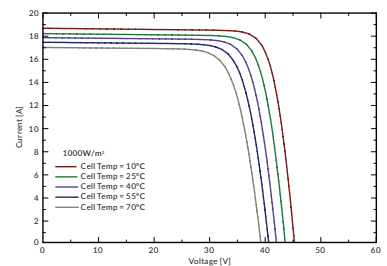

OPERATING CHARACTERISTICS

Operating Module Temperature	-40°C to +85°C
Maximum System Voltage	1500 DC (IEC)
Maximum Series Fuse Rating	35A
Power Tolerance	0/+5W

TEMPERATURE CHARACTERISTICS

Nominal Operating Temperature (NMOT)	45±2°C
Temperature Coefficient of Pmax	-0.29%/°C
Temperature Coefficient of Voc	-0.25%/°C
Temperature Coefficient of Isc	+0.045%/°C

Note: The technical parameters included in this datasheet may have minor deviations, and Luxen does not guarantee absolute accuracy. Due to ongoing product innovation and enhancements, Luxen reserves the right to modify the information in this manual at any time without prior notice. Customers should obtain the latest version of the technical manual when signing the contract, and it shall be considered an integral part of the binding contract between the parties. Please note that qualified professionals should handle and install solar modules to ensure optimal module performance.