

LUXNERI® SERIES **N**6



685-705W Mono FULL BLACK

132 Half-Cell Layout

G12/210mm N-TYPE Cell

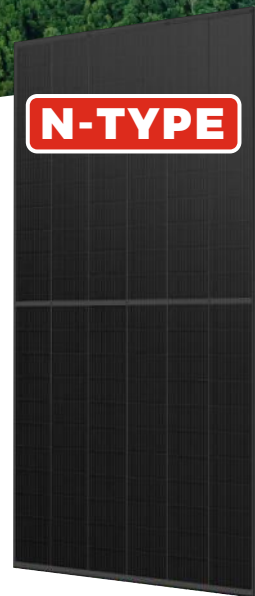

LECO N-TYPE Cell Technology



Full Black Appearance for Aesthetic Effect



SMBB Half Cut Cell Technology



Excellent Anti-PID Low LID Performance



Less Hot Spot Shading Effects



Higher Power Output Lower BOS & LCOE

Linear Performance Warranty

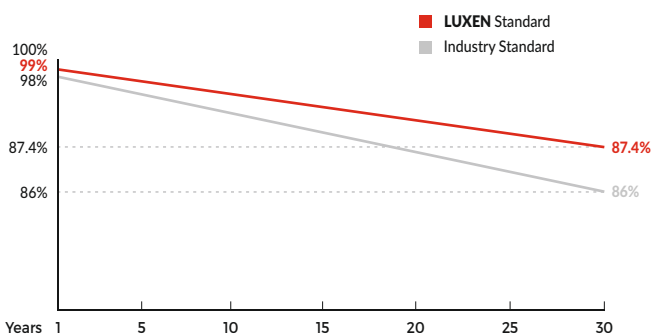

* LUXEN N-TYPE: Standard warranty 15 years, can be extended up to 20 years.

Insured By



Comprehensive Certificates

- ISO9001:2015 QMS
- ISO14001:2015 EMS
- ISO45001:2018 OHSMS
- IEC61215/IEC61730 Standard Quality
- IEC61701/IEC62716 Salt/Mist/Ammonia Tests



MECHANICAL CHARACTERISTICS

Solar Cells	N-type Mono
No. of Cells	132 (6x22)
Dimensions	2384 x 1303 x 35mm
Weight	34.0kg
Front Glass	3.2mm coated tempered glass
Frame	Anodized aluminium alloy (reinforced high-load optional)
Junction Box	Ip68 rated (3 by pass diodes)
	4.0mm ²
Output Cables	250mm (+) / 350mm (-)
	Length can be customized
Connectors	Mc4 compatible
Mechanical load test	Front 5400Pa / Rear 2400Pa

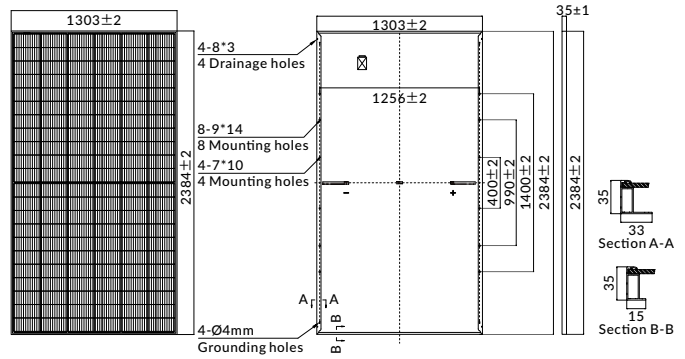

ELECTRICAL PARAMETERS

POWER CLASS	LNET-685N		LNET-690N		LNET-695N		LNET-700N		LNET-705N	
	STC	NMOT	STC	NMOT	STC	NMOT	STC	NMOT	STC	NMOT
Maximum power (Pmax)	685W	522W	690W	526W	695W	530W	700W	534W	705W	538W
Open Circuit Voltage (Voc)	47.03V	43.37V	47.17V	43.49V	47.32V	43.61V	47.46V	43.73V	47.60V	43.85V
Short Circuit Current (Isc)	18.67A	15.45A	18.74A	15.51A	18.81A	15.57A	18.88A	15.63A	18.95A	15.69A
Voltage at Maximum power (Vmpp)	39.46V	36.48V	39.61V	36.60V	39.76V	36.73V	39.91V	36.85V	40.06V	36.98V
Current Maximum Power (Impp)	17.36A	14.31A	17.42A	14.37A	17.48A	14.43A	17.54A	14.49A	17.60A	14.55A
MODULE EFFICIENCY (%)	22.05%		22.21%		22.37%		22.53%		22.70%	

STC: Irradiance 1000W/m², cell temperature 25°C, AM1.5G NMOT: Irradiance 800W/m², ambient temperature 20°C, wind speed 1m/s, AM1.5G

PACKING CONFIGURATION

Container	40'HQ
Pieces per pallet	32
Pallets per container	18
Pieces per container	576

I-V CURVE

LNET-690N/I-V

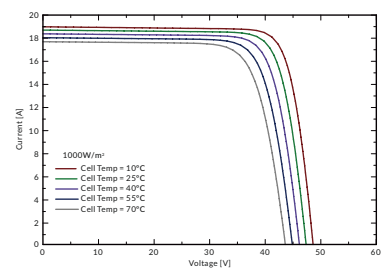
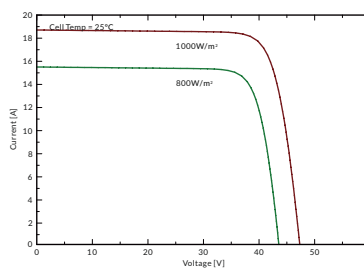

OPERATING CHARACTERISTICS

Operating Module Temperature	-40°C to +85°C
Maximum System Voltage	1500 DC (IEC)
Maximum Series Fuse Rating	35A
Power Tolerance	0/+5W

TEMPERATURE CHARACTERISTICS

Nominal Operating Temperature (NMOT)	45±2°C
Temperature Coefficient of Pmax	-0.29%/°C
Temperature Coefficient of Voc	-0.25%/°C
Temperature Coefficient of Isc	+0.045%/°C

Note: The technical parameters included in this datasheet may have minor deviations, and Luxen does not guarantee absolute accuracy. Due to ongoing product innovation and enhancements, Luxen reserves the right to modify the information in this manual at any time without prior notice. Customers should obtain the latest version of the technical manual when signing the contract, and it shall be considered an integral part of the binding contract between the parties. Please note that qualified professionals should handle and install solar modules to ensure optimal module performance.